

DENON®

DNP-730AE

NETWORK AUDIO PLAYER

Quick Start Guide

Kurzanleitung / Guide de démarrage rapide / Guida di Avvio Rapido /
Guía de inicio rápido / Snelhandleiding / Snabbstartsguide /
Краткое руководство пользователя / Skrócona instrukcja obsługi

Read Me First....

Bitte zuerst lesen... / Lisez-moi en premier... / Nota preliminare... /
Lea esto primero... / Lees mij eerst... / Läs detta först... /
Прочитайте в первую очередь... / Przeczytaj to najpierw....

ENGLISH

DEUTSCH

FRANÇAIS

ITALIANO

ESPAÑOL

NEDERLANDS

SVENSKA

РУССКИЙ

POLSKI

Welcome

Thank you for choosing a Denon network audio player. This guide provides step-by-step instructions for setting up your network audio player.











Please do not return this unit to the store – call for assistance.

If you need help... :

If you need additional help in solving problems, contact Denon customer service in your area. www.denon.com

Before You Begin

What's In the Box

Quick Start Guide		Power cord	
Owner's Manual		Audio cable	
Safety Instructions		IR control cable	
Notes on radio		Remote control unit	
Network audio player		R03/AAA batteries	

Required for Basic connections

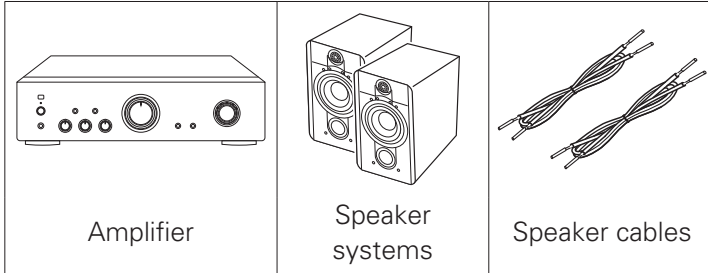

Required for Network connections

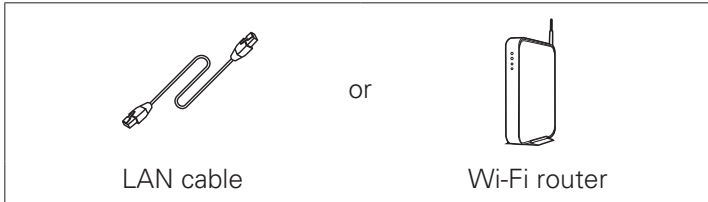

These drawings are for illustrative purposes only and may not represent the actual product(s).

Download the Denon “Hi-Fi Remote” app Scan the QR code to download and install the Denon “Hi-Fi Remote” app using your smartphone and a scanning app or manually search the Apple App store or Google Play store for the “Denon Hi-Fi Remote”



Setup Steps

There are five steps to the setup process.

- 1** Installing batteries in the remote control unit
- 2** Connect to the amplifier
- 3** Operate this unit with an iPad, iPhone or Android smartphone
- 4** Connect to the network
- 5** Enjoying your music!

1 Installing batteries in the remote control unit

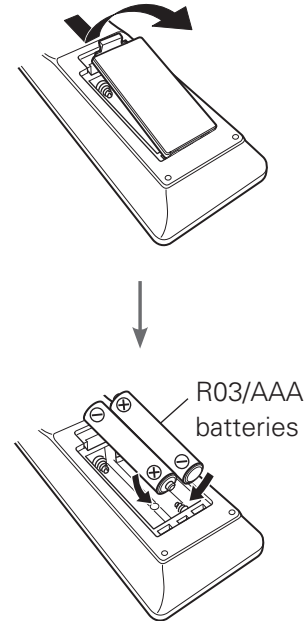

2 Connect to the amplifier

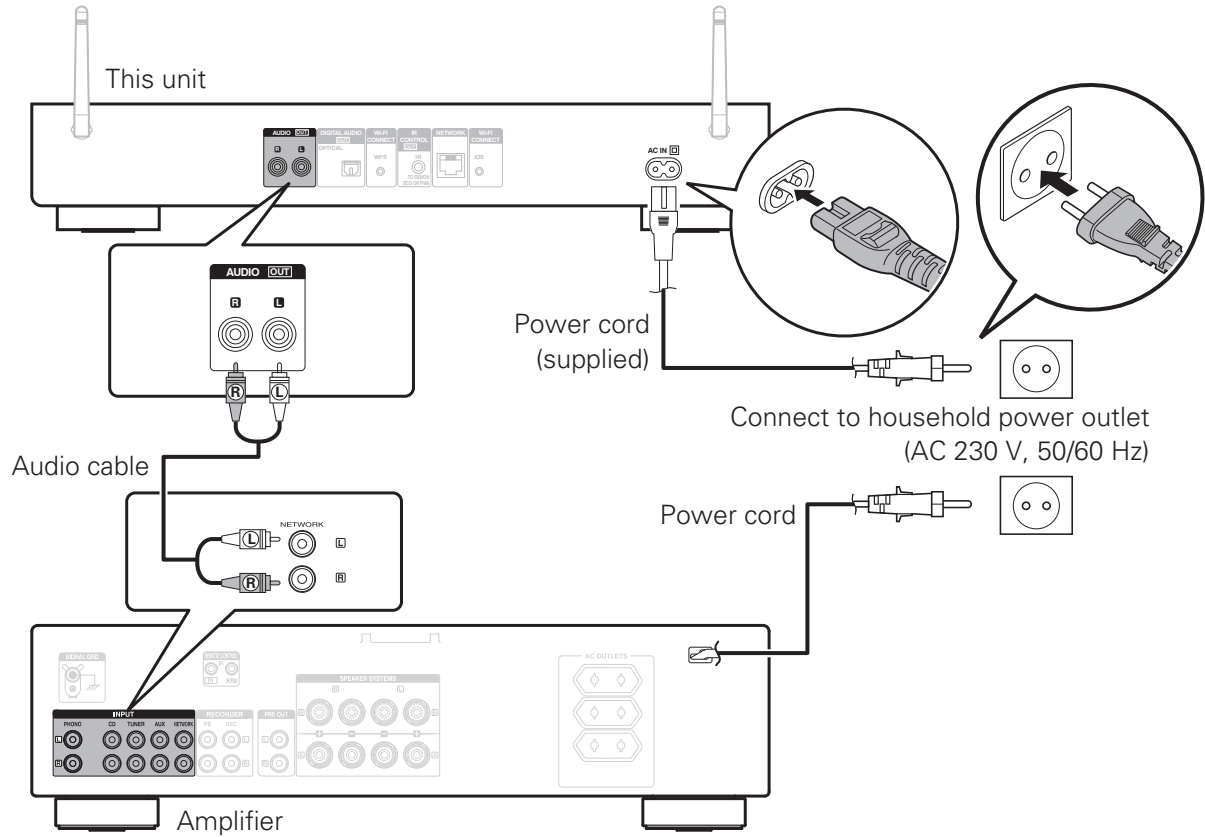

3 Operate this unit with an iPad, iPhone or Android smartphone

When this unit is connected to a Denon amplifier or CD player, the amplifier or CD player can be operated using the Denon "Hi-Fi Remote" app.

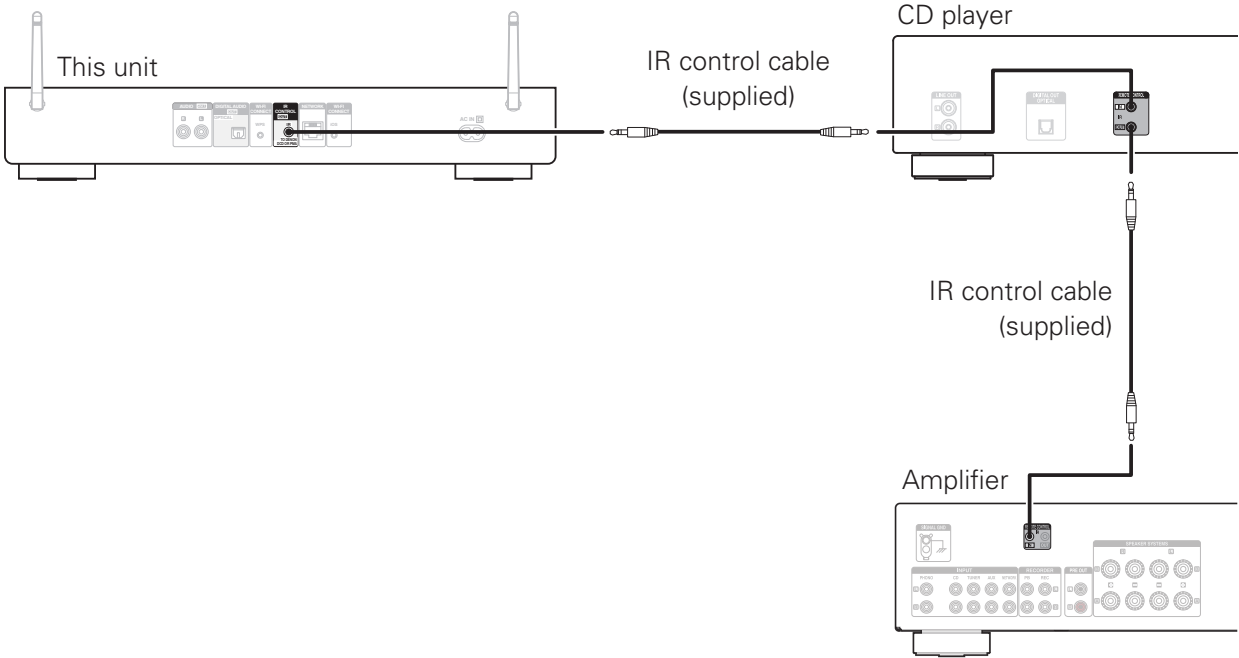

4 Connect to the network

Wired LAN

When connecting cables (wired connection), connect a LAN cable between your network audio player and your network router.

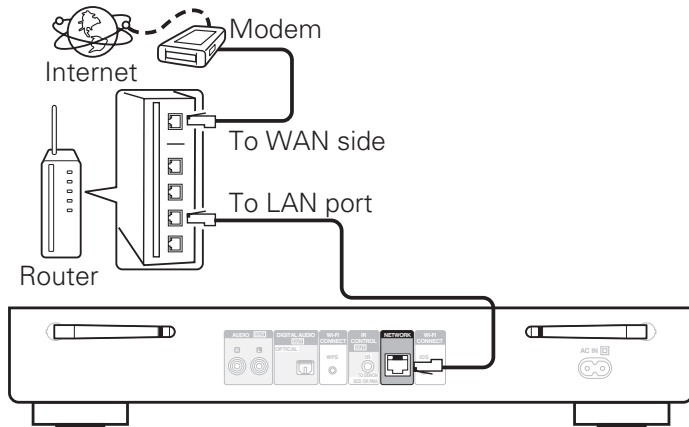

Wireless LAN

When using a wireless connection (Wi-Fi), rotate the antennas upward.

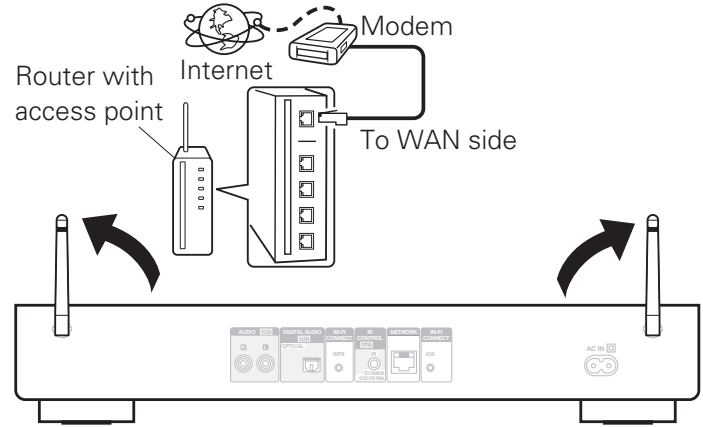

Choose from one of the following options

Wireless

iOS device
iOS version 7
or later



iOS device +
USB cable
iOS version 5
or later



No WPS router



Wi-Fi router

WPS router



Wi-Fi router

1 Power on

2 Select language

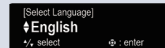

3 Make sure your iOS device is connected to your WiFi Network. Select the network named "DNP-730AE" from the Settings/Wi-Fi screen on your device



3 Make sure your iOS device is connected to your WiFi Network. Connect your iOS device to the front using your USB cable.

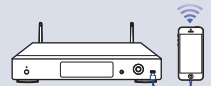

3 Select "Wi-Fi - scan" and wait as your DNP-730AE looks for available networks

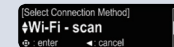

3 Press the WPS button on your router



Wired

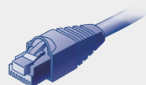

- 1 Connect a network cable between your DNP-730AE and your router (cable not included)
- 2 Power on
- 3 Select language
- 4 Please wait while your DNP-730AE connects to your wired network.

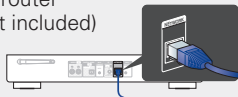

- 4 Follow the instructions and tap Next



- 5 Please wait as completing the connection can take a few minutes. The front panel of the DNP-730AE will show the status of the connection

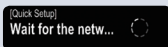

- 4 Press the iOS Button on the back of your DNP-730AE

Wi-Fi Sharing

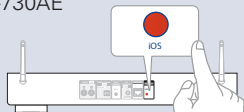

- 5 This message will appear on your iOS device. Select "Allow"



Connected!

- 4 Select your network name. If your network name is not listed, select "Rescan"

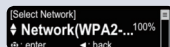

- 5 Enter your network password using the number keys on the remote control

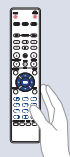
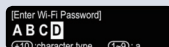

- 4 Within 2 minutes, press the WPS button on the back of your DNP-730AE

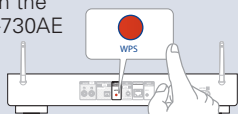

- 5 Please wait as completing the connection can take a few minutes. The front panel of the DNP-730AE will show the status of the connection

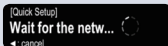

Network Control Setting

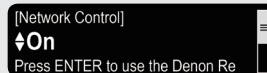

Select Network Control ON to control DNP-730AE from your smartphone, use Apple AirPlay® and maintain constant network access. Power Consumption during standby power will be slightly higher.

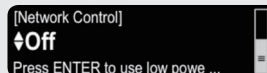

Select Network Control OFF to reduce power consumption during standby. You can not turn on your DNP-730AE from your smartphone or use Apple AirPlay until your DNP-730AE is powered on manually and connects to your network.

5 Enjoying your music!

❑ Enjoying Internet Radio

- 1 Press **INTERNET RADIO**.
- 2 Select the item, then press **ENTER**.
- 3 Repeat step 2 to select the station, then press **ENTER**.



❑ Enjoying music using Apple AirPlay

- 1 Open Control Center (iOS 7 and later) by swiping up from the bottom of your screen, then tap AirPlay.
- 2 Select the “Denon DNP-730AE” from the AirPlay Device list.

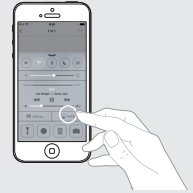

Owner's Manual

Please reference to the Owner's Manual for more details about the setup and operation of the network audio player and its features.

❑ Online Version

Enter the following URL into your web browser:
manuals.denon.com/DNP730AE/EU/EN/



Online Manual

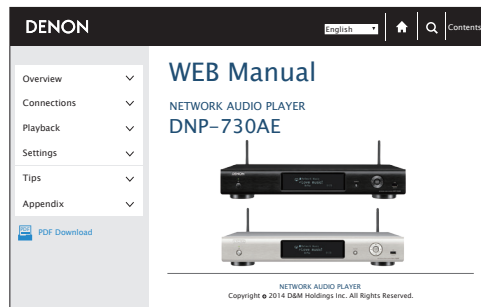

❑ Printable Version

Access the print version of the owner's manual from the included CD-ROM or select the "PDF Download" link from the Online Version.

1

Insert the disc into your PC.

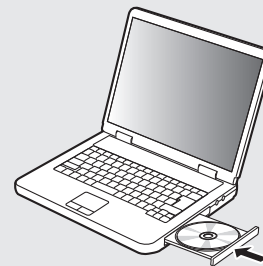

2

Follow the screen or double click on the PDF file.

DENON®

www.denon.com

D&M Holdings Inc.
Printed in China 5411 11224 00AD